

# Amplitude Modulation Fundamentals

In the modulation process, the baseband voice, video, or digital signal modifies another, higher-frequency signal called the **carrier**, which is usually a sine wave. A sine wave carrier can be modified by the intelligence signal through amplitude modulation, frequency modulation, or phase modulation. The focus of this chapter is amplitude modulation (AM).

Carrier

Amplitude modulation (AM)

## Objectives

After completing this chapter, you will be able to:

- Calculate the modulation index and percentage of modulation of an AM signal, given the amplitudes of the carrier and modulating signals.
- Define overmodulation and explain how to alleviate its effects.
- Explain how the power in an AM signal is distributed between the carrier and the sideband, and then compute the carrier and sideband powers, given the percentage of modulation.
- Compute sideband frequencies, given carrier and modulating signal frequencies.
- Compare time-domain, frequency-domain, and phasor representations of an AM signal.
- Explain what is meant by the terms **DSB** and **SSB** and state the main advantages of an SSB signal over a conventional AM signal.
- Calculate peak envelope power (PEP), given signal voltages and load impedances.

## 3-1 AM Concepts

As the name suggests, in AM, the information signal varies the amplitude of the carrier sine wave. The instantaneous value of the carrier amplitude changes in accordance with the amplitude and frequency variations of the modulating signal. Figure 3-1 shows a single-frequency sine wave intelligence signal modulating a higher-frequency carrier. The carrier frequency remains constant during the modulation process, but its amplitude varies in accordance with the modulating signal. An increase in the amplitude of the modulating signal causes the amplitude of the carrier to increase. Both the positive and the negative peaks of the carrier wave vary with the modulating signal. An increase or a decrease in the amplitude of the modulating signal causes a corresponding increase or decrease in both the positive and the negative peaks of the carrier amplitude.

An imaginary line connecting the positive peaks and negative peaks of the carrier waveform (the dashed line in Fig. 3-1) gives the exact shape of the modulating information signal. This imaginary line on the carrier waveform is known as the *envelope*.

Envelope

Because complex waveforms such as that shown in Fig. 3-1 are difficult to draw, they are often simplified by representing the high-frequency carrier wave as many equally spaced vertical lines whose amplitudes vary in accordance with a modulating signal, as in Fig. 3-2. This method of representation is used throughout this book.

The signals illustrated in Figs. 3-1 and 3-2 show the variation of the carrier amplitude with respect to time and are said to be in the time domain. Time-domain signals—voltage or current variations that occur over time—are displayed on the screen of an oscilloscope.

Using trigonometric functions, we can express the sine wave carrier with the simple expression

$$v_c = V_c \sin 2\pi f_c t$$

In this expression,  $v_c$  represents the instantaneous value of the carrier sine wave voltage at some specific time in the cycle;  $V_c$  represents the peak value of the constant unmodulated carrier sine wave as measured between zero and the maximum amplitude of either the positive-going or the negative-going alternations (Fig. 3-1);  $f_c$  is the frequency of the carrier sine wave; and  $t$  is a particular point in time during the carrier cycle.

A sine wave modulating signal can be expressed with a similar formula

$$v_m = V_m \sin 2\pi f_m t$$

where  $v_m$  = instantaneous value of information signal

$V_m$  = peak amplitude of information signal

$f_m$  = frequency of modulating signal

**Figure 3-1** Amplitude modulation. (a) The modulating or information signal. (b) The modulated carrier.

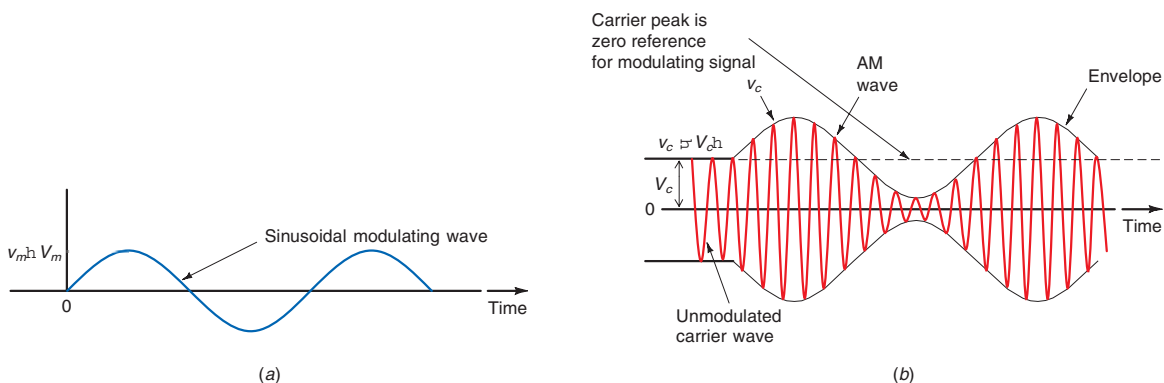

**Figure 3-2** A simplified method of representing an AM high-frequency sine wave.

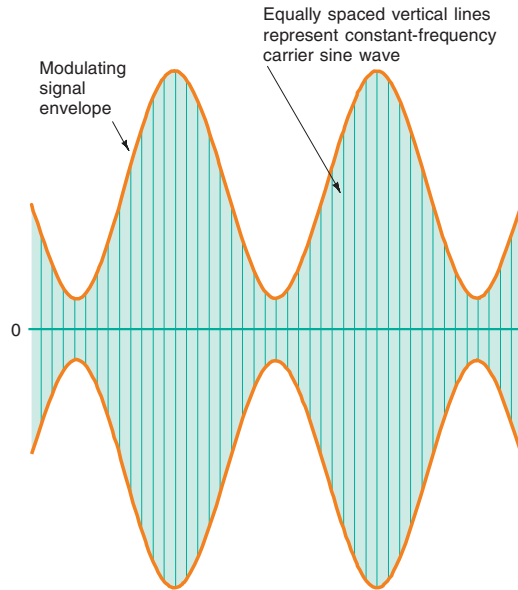

In Fig. 3-1, the modulating signal uses the peak value of the carrier rather than zero as its reference point. The envelope of the modulating signal varies above and below the peak carrier amplitude. That is, the zero reference line of the modulating signal coincides with the peak value of the unmodulated carrier. Because of this, the relative amplitudes of the carrier and modulating signal are important. In general, the amplitude of the modulating signal should be less than the amplitude of the carrier. When the amplitude of the modulating signal is greater than the amplitude of the carrier, distortion will occur, causing incorrect information to be transmitted. In amplitude modulation, it is particularly important that the peak value of the modulating signal be less than the peak value of the carrier. Mathematically,

$$V_m < V_c$$

Values for the carrier signal and the modulating signal can be used in a formula to express the complete modulated wave. First, keep in mind that the peak value of the carrier is the reference point for the modulating signal; the value of the modulating signal is added to or subtracted from the peak value of the carrier. The instantaneous value of either the top or the bottom voltage envelope  $v_1$  can be computed by using the equation

$$v_1 = V_c + v_m = V_c + V_m \sin 2\pi f_m t$$

which expresses the fact that the instantaneous value of the modulating signal algebraically adds to the peak value of the carrier. Thus we can write the instantaneous value of the complete modulated wave  $v_2$  by substituting  $v_1$  for the peak value of carrier voltage  $V_c$  as follows:

$$v_2 = v_1 \sin 2\pi f_c t$$

Now substituting the previously derived expression for  $v_1$  and expanding, we get the following:

$$v_2 = (V_c + V_m \sin 2\pi f_m t) \sin 2\pi f_c t = V_c \sin 2\pi f_c t + (V_m \sin 2\pi f_m t) (\sin 2\pi f_c t)$$

### GOOD TO KNOW

In this text, radian measure will be used for all angles unless otherwise indicated. One radian is approximately 57.3°.

### GOOD TO KNOW

If the amplitude of the modulating signal is greater than the amplitude of the carrier, distortion will occur.

**Figure 3-3** Amplitude modulator showing input and output signals.

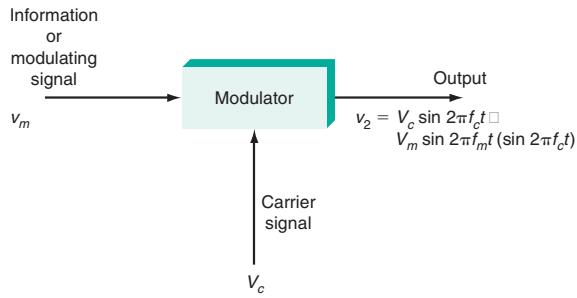

where  $v_2$  is the instantaneous value of the AM wave (or  $v_{AM}$ ),  $V_c \sin 2\pi f_c t$  is the carrier waveform, and  $(V_m \sin 2\pi f_m t) (\sin 2\pi f_c t)$  is the carrier waveform multiplied by the modulating signal waveform. It is the second part of the expression that is characteristic of AM. A circuit must be able to produce mathematical multiplication of the carrier and modulating signals in order for AM to occur. The AM wave is the product of the carrier and modulating signals.

**Modulator**

The circuit used for producing AM is called a *modulator*. Its two inputs, the carrier and the modulating signal, and the resulting outputs are shown in Fig. 3-3. Amplitude modulators compute the product of the carrier and modulating signals. Circuits that compute the product of two analog signals are also known as analog multipliers, mixers, converters, product detectors, and phase detectors. A circuit that changes a lower-frequency baseband or intelligence signal to a higher-frequency signal is usually called a modulator. A circuit used to recover the original intelligence signal from an AM wave is known as a detector or demodulator. Mixing and detection applications are discussed in detail in later chapters.

## 3-2 Modulation Index and Percentage of Modulation

As stated previously, for undistorted AM to occur, the modulating signal voltage  $V_m$  must be less than the carrier voltage  $V_c$ . Therefore the relationship between the amplitude of the modulating signal and the amplitude of the carrier signal is important. This relationship, known as the *modulation index*  $m$  (also called the modulating factor or coefficient, or the degree of modulation), is the ratio

**Modulation index  $m$**

$$m = \frac{V_m}{V_c}$$

These are the peak values of the signals, and the carrier voltage is the unmodulated value.

**Percentage of modulation**

Multiplying the modulation index by 100 gives the *percentage of modulation*. For example, if the carrier voltage is 9 V and the modulating signal voltage is 7.5 V, the modulation factor is 0.8333 and the percentage of modulation is  $0.833 \times 100 = 83.33$ .

### Overmodulation and Distortion

The modulation index should be a number between 0 and 1. If the amplitude of the modulating voltage is higher than the carrier voltage,  $m$  will be greater than 1, causing

**Figure 3-4** Distortion of the envelope caused by overmodulation where the modulating signal amplitude  $V_m$  is greater than the carrier signal  $V_c$ .

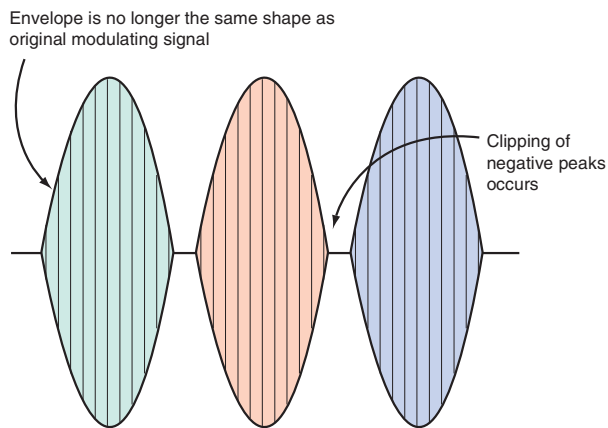

*distortion* of the modulated waveform. If the distortion is great enough, the intelligence signal becomes unintelligible. Distortion of voice transmissions produces garbled, harsh, or unnatural sounds in the speaker. Distortion of video signals produces a scrambled and inaccurate picture on a TV screen.

Simple distortion is illustrated in Fig. 3-4. Here a sine wave information signal is modulating a sine wave carrier, but the modulating voltage is much greater than the carrier voltage, resulting in a condition called *overmodulation*. As you can see, the waveform is flattened at the zero line. The received signal will produce an output waveform in the shape of the envelope, which in this case is a sine wave whose negative peaks have been clipped off. If the amplitude of the modulating signal is less than the carrier amplitude, no distortion will occur. The ideal condition for AM is when  $V_m = V_c$ , or  $m = 1$ , which gives 100 percent modulation. This results in the greatest output power at the transmitter and the greatest output voltage at the receiver, with no distortion.

Preventing overmodulation is tricky. For example, at different times during voice transmission voices will go from low amplitude to high amplitude. Normally, the amplitude of the modulating signal is adjusted so that only the voice peaks produce 100 percent modulation. This prevents overmodulation and distortion. Automatic circuits called *compression circuits* solve this problem by amplifying the lower-level signals and suppressing or compressing the higher-level signals. The result is a higher average power output level without overmodulation.

Distortion caused by overmodulation also produces adjacent channel interference. Distortion produces a nonsinusoidal information signal. According to Fourier theory, any nonsinusoidal signal can be treated as a fundamental sine wave at the frequency of the information signal plus harmonics. Obviously, these harmonics also modulate the carrier and can cause interference with other signals on channels adjacent to the carrier.

## Percentage of Modulation

The modulation index can be determined by measuring the actual values of the modulation voltage and the carrier voltage and computing the ratio. However, it is more common

Distortion

Overmodulation

### GOOD TO KNOW

Distortion caused by overmodulation also produces adjacent channel interference.

Compression circuit

**Figure 3-5** An AM wave showing peaks ( $V_{\max}$ ) and troughs ( $V_{\min}$ ).

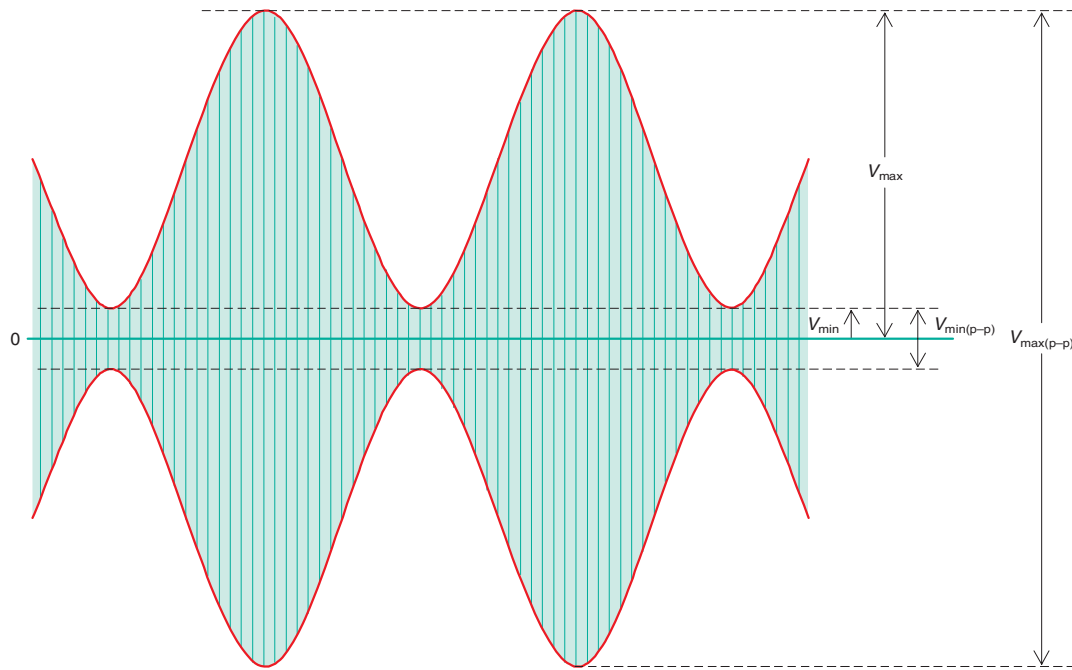

to compute the modulation index from measurements taken on the composite modulated wave itself. When the AM signal is displayed on an oscilloscope, the modulation index can be computed from  $V_{\max}$  and  $V_{\min}$ , as shown in Fig. 3-5. The peak value of the modulating signal  $V_m$  is one-half the difference of the peak and trough values:

$$V_m = \frac{V_{\max} - V_{\min}}{2}$$

As shown in Fig. 3-5,  $V_{\max}$  is the peak value of the signal during modulation, and  $V_{\min}$  is the lowest value, or trough, of the modulated wave. The  $V_{\max}$  is one-half the peak-to-peak value of the AM signal, or  $V_{\max(p-p)}/2$ . Subtracting  $V_{\min}$  from  $V_{\max}$  produces the peak-to-peak value of the modulating signal. One-half of that, of course, is simply the peak value.

The peak value of the carrier signal  $V_c$  is the average of the  $V_{\max}$  and  $V_{\min}$  values:

$$V_c = \frac{V_{\max} + V_{\min}}{2}$$

The modulation index is

$$m = \frac{V_{\max} - V_{\min}}{V_{\max} + V_{\min}}$$

The values for  $V_{\max(p-p)}$  and  $V_{\min(p-p)}$  can be read directly from an oscilloscope screen and plugged directly into the formula to compute the modulation index.

The amount, or depth, of AM is more commonly expressed as the percentage of modulation rather than as a fractional value. In Example 3-1, the percentage of modulation is  $100 \times m$ , or 66.2 percent. The maximum amount of modulation without signal distortion, of course, is 100 percent, where  $V_c$  and  $V_m$  are equal. At this time,  $V_{\min} = 0$  and  $V_{\max} = 2V_m$ , where  $V_m$  is the peak value of the modulating signal.

## Example 3-1

Suppose that on an AM signal, the  $V_{\max(p-p)}$  value read from the graticule on the oscilloscope screen is 5.9 divisions and  $V_{\min(p-p)}$  is 1.2 divisions.

- a. What is the modulation index?

$$m = \frac{V_{\max} - V_{\min}}{V_{\max} + V_{\min}} = \frac{5.9 - 1.2}{5.9 + 1.2} = \frac{4.7}{7.1} = 0.662$$

- b. Calculate  $V_c$ ,  $V_m$ , and  $m$  if the vertical scale is 2 V per division. (*Hint:* Sketch the signal.)

$$V_c = \frac{V_{\max} + V_{\min}}{2} = \frac{5.9 + 1.2}{2} = \frac{7.1}{2} = 3.55 @ \frac{2 \text{ V}}{\text{div}}$$

$$V_c = 3.55 \times 2 \text{ V} = 7.1 \text{ V}$$

$$V_m = \frac{V_{\max} - V_{\min}}{2} = \frac{5.9 - 1.2}{2} = \frac{4.7}{2}$$

$$= 2.35 @ \frac{2 \text{ V}}{\text{div}}$$

$$V_m = 2.35 \times 2 \text{ V} = 4.7 \text{ V}$$

$$m = \frac{V_m}{V_c} = \frac{4.7}{7.1} = 0.662$$

## 3-3 Sidebands and the Frequency Domain

Whenever a carrier is modulated by an information signal, new signals at different frequencies are generated as part of the process. These new frequencies, which are called *side frequencies*, or *sidebands*, occur in the frequency spectrum directly above and directly below the carrier frequency. More specifically, the sidebands occur at frequencies that are the sum and difference of the carrier and modulating frequencies. When signals of more than one frequency make up a waveform, it is often better to show the AM signal in the frequency domain rather than in the time domain.

Sideband

### Sideband Calculations

When only a single-frequency sine wave modulating signal is used, the modulation process generates two sidebands. If the modulating signal is a complex wave, such as voice or video, a whole range of frequencies modulate the carrier, and thus a whole range of sidebands are generated.

The upper sideband  $f_{\text{USB}}$  and lower sideband  $f_{\text{LSB}}$  are computed as

$$f_{\text{USB}} = f_c + f_m \quad \text{and} \quad f_{\text{LSB}} = f_c - f_m$$

where  $f_c$  is the carrier frequency and  $f_m$  is the modulating frequency.

The existence of sidebands can be demonstrated mathematically, starting with the equation for an AM signal described previously:

$$\square_{\text{AM}} = V_c \sin 2\square f_c t + (V_m \sin 2\square f_m t) (\sin 2\square f_c t)$$

By using the trigonometric identity that says that the product of two sine waves is

$$\sin A \sin B = \frac{\cos(A - B)}{2} - \frac{\cos(A + B)}{2}$$

and substituting this identity into the expression a modulated wave, the instantaneous amplitude of the signal becomes

$$v_{AM} = V_c \sin 2\pi f_c t + \frac{V_m}{2} \cos 2\pi t(f_c - f_m) - \frac{V_m}{2} \cos 2\pi t(f_c + f_m)$$

where the first term is the carrier; the second term, containing the difference  $f_c - f_m$ , is the lower sideband; and the third term, containing the sum  $f_c + f_m$ , is the upper sideband.

For example, assume that a 400-Hz tone modulates a 300-kHz carrier. The upper and lower sidebands are

$$f_{USB} = 300,000 + 400 = 300,400 \text{ Hz or } 300.4 \text{ kHz}$$

$$f_{LSB} = 300,000 - 400 = 299,600 \text{ Hz or } 299.6 \text{ kHz}$$

Observing an AM signal on an oscilloscope, you can see the amplitude variations of the carrier with respect to time. This time-domain display gives no obvious or outward indication of the existence of the sidebands, although the modulation process does indeed produce them, as the equation above shows. An AM signal is really a composite signal formed from several components: the carrier sine wave is added to the upper and lower sidebands, as the equation indicates. This is illustrated graphically in Fig. 3-6.

**Figure 3-6** The AM wave is the algebraic sum of the carrier and upper and lower sideband sine waves. (a) Intelligence or modulating signal. (b) Lower sideband. (c) Carrier. (d) Upper sideband. (e) Composite AM wave.

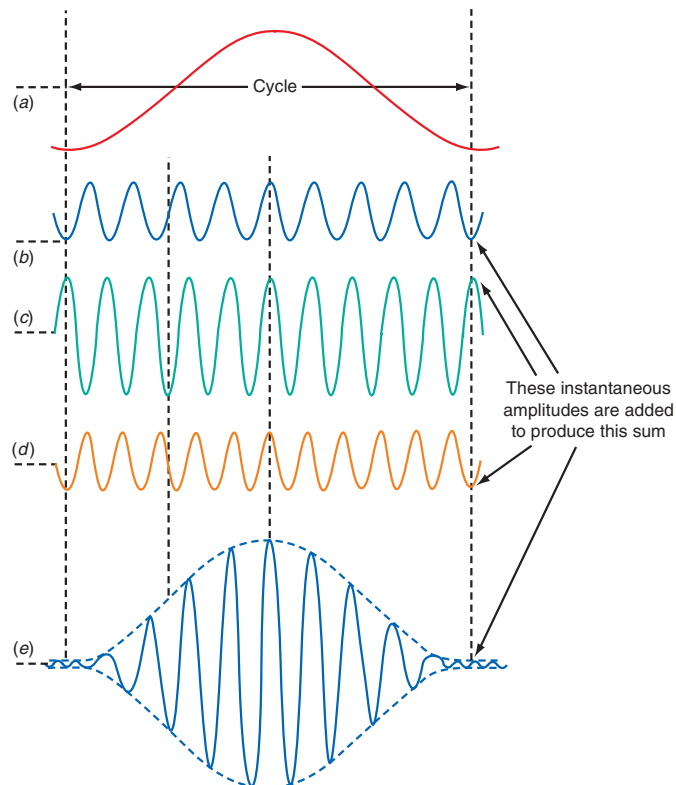



**Figure 3-7** A frequency-domain display of an AM signal (voltage).

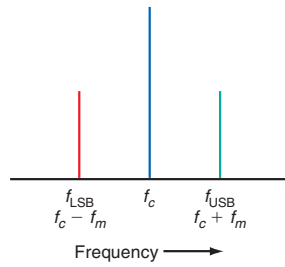

Adding these signals together algebraically at every instantaneous point along the time axis and plotting the result yield the AM wave shown in the figure. It is a sine wave at the carrier frequency whose amplitude varies as determined by the modulating signal.

## Frequency-Domain Representation of AM

Another method of showing the sideband signals is to plot the carrier and sideband amplitudes with respect to frequency, as in Fig. 3-7. Here the horizontal axis represents frequency, and the vertical axis represents the amplitudes of the signals. The signals may be voltage, current, or power amplitudes and may be given in peak or rms values. A plot of signal amplitude versus frequency is referred to as a *frequency-domain display*. A test instrument known as a *spectrum analyzer* is used to display the frequency domain of a signal.

Frequency-domain display

Spectrum analyzer

Figure 3-8 shows the relationship between the time- and frequency-domain displays of an AM signal. The time and frequency axes are perpendicular to each other. The amplitudes shown in the frequency-domain display are the peak values of the carrier and sideband sine waves.

Whenever the modulating signal is more complex than a single sine wave tone, multiple upper and lower sidebands are produced by the AM process. For example, a voice

**Figure 3-8** The relationship between the time and frequency domains.

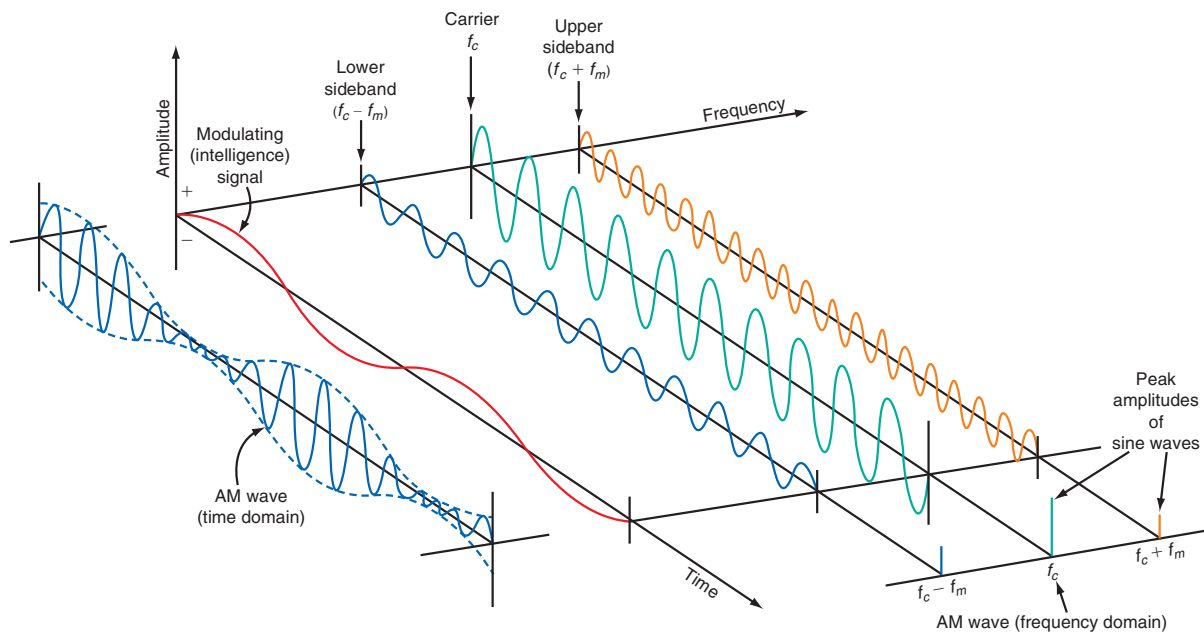

**Figure 3-9** The upper and lower sidebands of a voice modulator AM signal.

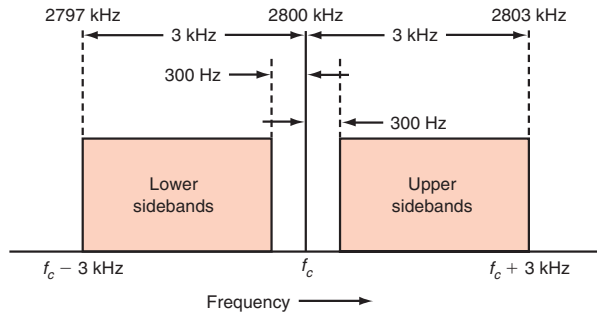

signal consists of many sine wave components of different frequencies mixed together. Recall that voice frequencies occur in the 300- to 3000-Hz range. Therefore, voice signals produce a range of frequencies above and below the carrier frequency, as shown in Fig. 3-9. These sidebands take up spectrum space. The total bandwidth of an AM signal is calculated by computing the maximum and minimum sideband frequencies. This is done by finding the sum and difference of the carrier frequency and maximum modulating frequency (3000 Hz, or 3 kHz, in Fig. 3-9). For example, if the carrier frequency is 2.8 MHz (2800 kHz), then the maximum and minimum sideband frequencies are

$$f_{\text{USB}} = 2800 + 3 = 2803 \text{ kHz} \quad \text{and} \quad f_{\text{LSB}} = 2800 - 3 = 2797 \text{ kHz}$$

The total bandwidth is simply the difference between the upper and lower sideband frequencies:

$$\text{BW} = f_{\text{USB}} - f_{\text{LSB}} = 2803 - 2797 = 6 \text{ kHz}$$

As it turns out, the bandwidth of an AM signal is twice the highest frequency in the modulating signal:  $\text{BW} = 2f_m$ , where  $f_m$  is the maximum modulating frequency. In the case of a voice signal whose maximum frequency is 3 kHz, the total bandwidth is simply

$$\text{BW} = 2(3 \text{ kHz}) = 6 \text{ kHz}$$

### Example 3-2

A standard AM broadcast station is allowed to transmit modulating frequencies up to 5 kHz. If the AM station is transmitting on a frequency of 980 kHz, compute the maximum and minimum upper and lower sidebands and the total bandwidth occupied by the AM station.

$$f_{\text{USB}} = 980 + 5 = 985 \text{ kHz}$$

$$f_{\text{LSB}} = 980 - 5 = 975 \text{ kHz}$$

$$\text{BW} = f_{\text{USB}} - f_{\text{LSB}} = 985 - 975 = 10 \text{ kHz} \quad \text{or}$$

$$\text{BW} = 2(5 \text{ kHz}) = 10 \text{ kHz}$$

As Example 3-2 indicates, an AM broadcast station has a total bandwidth of 10 kHz. In addition, AM broadcast stations are spaced every 10 kHz across the spectrum from 540 to 1600 kHz. This is illustrated in Fig. 3-10. The sidebands from the first AM broadcast frequency extend down to 535 kHz and up to 545 kHz, forming a 10-kHz channel for the signal. The highest channel frequency is 1600 kHz, with sidebands extending

**Figure 3-10** Frequency spectrum of AM broadcast band.

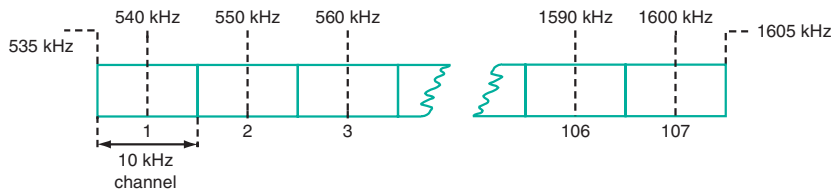

from 1595 up to 1605 kHz. There are a total of 107 10-kHz-wide channels for AM radio stations.

## Pulse Modulation

When complex signals such as pulses or rectangular waves modulate a carrier, a broad spectrum of sidebands are produced. According to Fourier theory, complex signals such as square waves, triangular waves, sawtooth waves, and distorted sine waves are simply made up of a fundamental sine wave and numerous harmonic signals at different amplitudes. Assume that a carrier is amplitude-modulated by a square wave which is made up of a fundamental sine wave and all odd harmonics. A modulating square wave will produce sidebands at frequencies based upon the fundamental sine wave as well as at the third, fifth, seventh, etc., harmonics, resulting in a frequency-domain plot like that shown in Fig. 3-11. As can be seen, pulses generate extremely wide-bandwidth signals. In order for a square wave to be transmitted and faithfully received without distortion or degradation, all the most significant sidebands must be passed by the antennas and the transmitting and receiving circuits.

Figure 3-12 shows the AM wave resulting when a square wave modulates a sine wave carrier. In Fig. 3-12(a), the percentage of modulation is 50; in Fig. 3-12(b), it is 100. In this case, when the square wave goes negative, it drives the carrier amplitude to zero. Amplitude modulation by square waves or rectangular binary pulses is referred to as *amplitude-shift keying (ASK)*. ASK is used in some types of data communication when binary information is to be transmitted.

Another crude type of amplitude modulation can be achieved by simply turning the carrier off and on. An example is the transmitting of Morse code by using dots and dashes.

Pulse modulation

Amplitude-shift keying (ASK)

**Figure 3-11** Frequency spectrum of an AM signal modulated by a square wave.

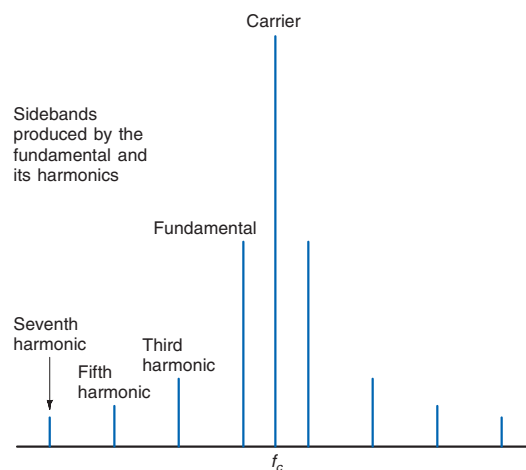

**Figure 3-12** Amplitude modulation of a sine wave carrier by a pulse or rectangular wave is called amplitude-shift keying. (a) Fifty percent modulation. (b) One hundred percent modulation.

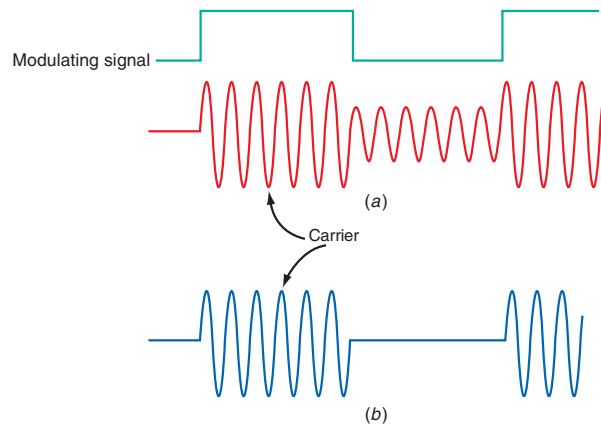

A dot is a short burst of carrier, and a dash is a longer burst of carrier. Figure 3-13 shows the transmission of the letter P, which is dot-dash-dash-dot (pronounced “dit-dah-dah-dit”). The time duration of a dash is 3 times the length of a dot, and the spacing between dots and dashes is one dot time. Code transmissions such as this are usually called *continuous-wave (CW) transmissions*. This kind of transmission is also referred to as *ON/OFF keying (OOK)*. Despite the fact that only the carrier is being transmitted, sidebands are generated by such ON/OFF signals. The sidebands result from the frequency or repetition rate of the pulses themselves plus their harmonics.

As indicated earlier, the distortion of an analog signal by overmodulation also generates harmonics. For example, the spectrum produced by a 500-Hz sine wave modulating a carrier of 1 MHz is shown in Fig. 3-14(a). The total bandwidth of the signal is 1 kHz. However, if the modulating signal is distorted, the second, third, fourth, and higher harmonics are generated. These harmonics also modulate the carrier, producing many more sidebands, as illustrated in Fig. 3-14(b). Assume that the distortion is such that the harmonic amplitudes beyond the fourth harmonic are insignificant (usually less than 1 percent); then the total bandwidth of the resulting signal is about 4 kHz instead of the 1-kHz bandwidth that would result without overmodulation and distortion. The harmonics can overlap into adjacent channels, where other signals may be present and interfere with them. Such harmonic sideband interference is sometimes called *splatter* because of the way it sounds at the receiver. Overmodulation and splatter are easily eliminated simply by reducing the level of the modulating signal by using gain control or in some cases by using amplitude-limiting or compression circuits.

**Figure 3-13** Sending the letter P by Morse code. An example of ON/OFF keying (OOK).

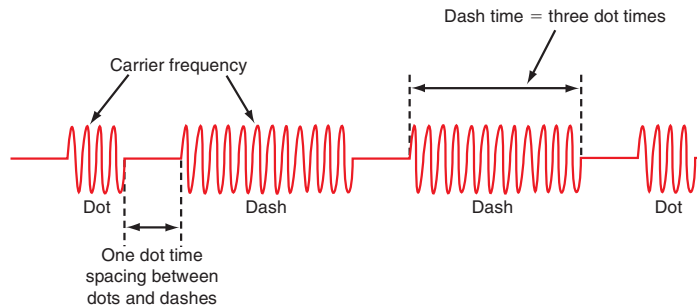

Continuous-wave (CW) transmission  
ON/OFF keying (OOK)

Splatter

**Figure 3-14** The effect of overmodulation and distortion on AM signal bandwidth. (a) Sine wave of 500 Hz modulating a 1-MHz carrier. (b) Distorted 500-Hz sine wave with significant second, third, and fourth harmonics.

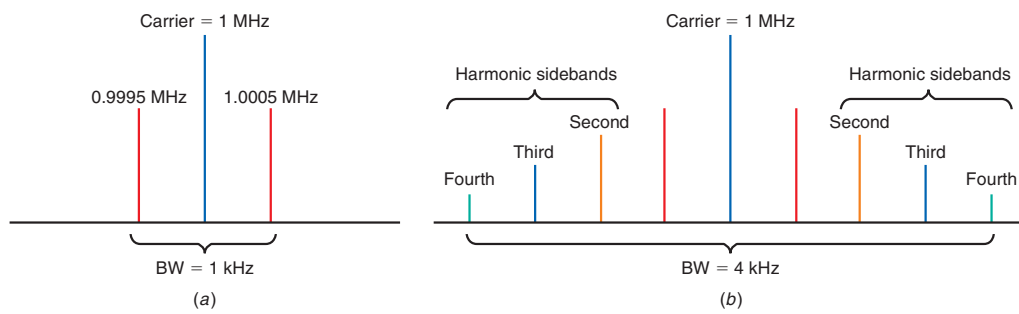

### 3-4 AM Power

In radio transmission, the AM signal is amplified by a power amplifier and fed to the antenna with a characteristic impedance that is ideally, but not necessarily, almost pure resistance. The AM signal is really a composite of several signal voltages, namely, the carrier and the two sidebands, and each of these signals produces power in the antenna. The total transmitted power  $P_T$  is simply the sum of the carrier power  $P_c$  and the power in the two sidebands  $P_{USB}$  and  $P_{LSB}$ :

$$P_T = P_c + P_{LSB} + P_{USB}$$

You can see how the power in an AM signal is distributed and calculated by going back to the original AM equation:

$$v_{AM} = V_c \sin 2\pi f_c t + \frac{V_m}{2} \cos 2\pi t(f_c - f_m) - \frac{V_m}{2} \cos 2\pi t(f_c + f_m)$$

where the first term is the carrier, the second term is the lower sideband, and the third term is the upper sideband.

Now, remember that  $V_c$  and  $V_m$  are peak values of the carrier and modulating sine waves, respectively. For power calculations, rms values must be used for the voltages. We can convert from peak to rms by dividing the peak value by  $\sqrt{2}$  or multiplying by 0.707. The rms carrier and sideband voltages are then

$$v_{AM} = \frac{V_c}{\sqrt{2}} \sin 2\pi f_c t + \frac{V_m}{2\sqrt{2}} \cos 2\pi t(f_c - f_m) - \frac{V_m}{2\sqrt{2}} \cos 2\pi t(f_c + f_m)$$

The power in the carrier and sidebands can be calculated by using the power formula  $P = V^2/R$ , where  $P$  is the output power,  $V$  is the rms output voltage, and  $R$  is the resistive part of the load impedance, which is usually an antenna. We just need to use the coefficients on the sine and cosine terms above in the power formula:

$$P_T = \frac{(V_c/\sqrt{2})^2}{R} + \frac{(V_m/2\sqrt{2})^2}{R} + \frac{(V_m/2\sqrt{2})^2}{R} = \frac{V_c^2}{2R} + \frac{V_m^2}{8R} + \frac{V_m^2}{8R}$$

Remembering that we can express the modulating signal  $V_m$  in terms of the carrier  $V_c$  by using the expression given earlier for the modulation index  $m = V_m/V_c$ ; we can write

$$V_m = mV_c$$

If we express the sideband powers in terms of the carrier power, the total power becomes

$$P_T = \frac{V_c^2}{2R} + \frac{(mV_c)^2}{8R} + \frac{(mV_c)^2}{8R} = \frac{V_c^2}{2R} + \frac{m^2V_c^2}{8R} + \frac{m^2V_c^2}{8R}$$

Since the term  $V_c^2/2R$  is equal to the rms carrier power  $P_c$ , it can be factored out, giving

$$P_T = \frac{V_c^2}{2R} \left( 1 + \frac{m^2}{4} + \frac{m^2}{4} \right)$$

Finally, we get a handy formula for computing the total power in an AM signal when the carrier power and the percentage of modulation are known:

$$P_T = P_c \left( 1 + \frac{m^2}{2} \right)$$

For example, if the carrier of an AM transmitter is 1000 W and it is modulated 100 percent ( $m = 1$ ), the total AM power is

$$P_T = 1000 \left( 1 + \frac{1^2}{2} \right) = 1500 \text{ W}$$

Of the total power, 1000 W of it is in the carrier. That leaves 500 W in both sidebands. Since the sidebands are equal in size, each sideband has 250 W.

For a 100 percent modulated AM transmitter, the total sideband power is always one-half that of the carrier power. A 50-kW transmitter carrier that is 100 percent modulated will have a sideband power of 25 kW, with 12.5 kW in each sideband. The total power for the AM signal is the sum of the carrier and sideband power, or 75 kW.

When the percentage of modulation is less than the optimum 100, there is much less power in the sidebands. For example, for a 70 percent modulated 250-W carrier, the total power in the composite AM signal is

$$P_T = 250 \left( 1 + \frac{0.7^2}{2} \right) = 250(1 + 0.245) = 311.25 \text{ W}$$

Of the total, 250 W is in the carrier, leaving  $311.25 - 250 = 61.25$  W in the sidebands. There is  $61.25/2$  or 30.625 W in each sideband.

### Example 3-3

An AM transmitter has a carrier power of 30 W. The percentage of modulation is 85 percent. Calculate (a) the total power and (b) the power in one sideband.

$$\text{a. } P_T = P_c \left( 1 + \frac{m^2}{2} \right) = 30 \left[ 1 + \frac{(0.85)^2}{2} \right] = 30 \left( 1 + \frac{0.7225}{2} \right)$$

$$P_T = 30(1.36125) = 40.8 \text{ W}$$

$$\text{b. } P_{\text{SB}} (\text{both}) = P_T - P_c = 40.8 - 30 = 10.8 \text{ W}$$

$$P_{\text{SB}} (\text{one}) = \frac{P_{\text{SB}}}{2} = \frac{10.8}{2} = 5.4 \text{ W}$$

In the real world, it is difficult to determine AM power by measuring the output voltage and calculating the power with the expression  $P = V^2/R$ . However, it is easy to measure the current in the load. For example, you can use an RF ammeter connected in series with an antenna to observe antenna current. When the antenna impedance is known, the output power is easily calculated by using the formula

$$P_T = I_T^2 R$$

where  $I_T = I_c \sqrt{1 + m^2/2}$ . Here  $I_c$  is the unmodulated carrier current in the load, and  $m$  is the modulation index. For example, the total output power of an 85 percent modulated AM transmitter, whose unmodulated carrier current into a 50- $\Omega$  antenna load impedance is 10 A, is

$$I_T = 10 \sqrt{1 + \frac{0.85^2}{2}} = 10 \sqrt{1.36125} = 11.67 \text{ A}$$

$$P_T = 11.67^2(50) = 136.2(50) = 6809 \text{ W}$$

One way to find the percentage of modulation is to measure both the modulated and the unmodulated antenna currents. Then, by algebraically rearranging the formula above,  $m$  can be calculated directly:

$$m = \sqrt{2 \left[ \left( \frac{I_T}{I_c} \right)^2 - 1 \right]}$$

Suppose that the unmodulated antenna current is 2.2 A. That is the current produced by the carrier only, or  $I_c$ . Now, if the modulated antenna current is 2.6 A, the modulation index is

$$m = \sqrt{2 \left[ \left( \frac{2.6}{2.2} \right)^2 - 1 \right]} = \sqrt{2[(1.18)^2 - 1]} = \sqrt{0.7934} = 0.89$$

The percentage of modulation is 89.

As you can see, the power in the sidebands depends on the value of the modulation index. The greater the percentage of modulation, the higher the sideband power and the higher the total power transmitted. Of course, maximum power appears in the sidebands when the carrier is 100 percent modulated. The power in each sideband  $P_{SB}$  is given by

$$P_{SB} = P_{LSB} = P_{USB} = \frac{P_c m^2}{4}$$

An example of a time-domain display of an AM signal (power) is as follows.

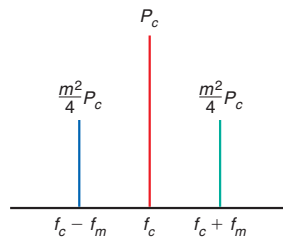

Assuming 100 percent modulation where the modulation factor  $m = 1$ , the power in each sideband is one-fourth, or 25 percent, of the carrier power. Since there are two sidebands, their power together represents 50 percent of the carrier power. For example, if the carrier power is 100 W, then at 100 percent modulation, 50 W will appear in the sidebands, 25 W in each. The total transmitted power, then, is the sum of the carrier and sideband powers, or 150 W. The goal in AM is to keep the percentage of modulation as high as possible without overmodulation so that maximum sideband power is transmitted.

The carrier power represents two-thirds of the total transmitted power. Assuming 100-W carrier power and a total power of 150 W, the carrier power percentage is  $100/150 = 0.667$ , or 66.7 percent. The sideband power percentage is thus  $50/150 = 0.333$ , or 33.3 percent.

The carrier itself conveys no information. The carrier can be transmitted and received, but unless modulation occurs, no information will be transmitted. When modulation occurs, sidebands are produced. It is easy to conclude, therefore, that all the transmitted information is contained within the sidebands. Only one-third of the total transmitted power is allotted to the sidebands, and the remaining two-thirds is literally wasted on the carrier.

At lower percentages of modulation, the power in the sidebands is even less. For example, assuming a carrier power of 500 W and a modulation of 70 percent, the power in each sideband is

$$P_{\text{SB}} = \frac{P_c m^2}{4} = \frac{500(0.7)^2}{4} = \frac{500(0.49)}{4} = 61.25 \text{ W}$$

and the total sideband power is 122.5 W. The carrier power, of course, remains unchanged at 500 W.

As stated previously, complex voice and video signals vary over a wide amplitude and frequency range, and 100 percent modulation occurs only on the peaks of the modulating signal. For this reason, the average sideband power is considerably lower than the ideal 50 percent that would be produced by 100 percent modulation. With less sideband power transmitted, the received signal is weaker and communication is less reliable.

### Example 3-4

An antenna has an impedance of 40  $\Omega$ . An unmodulated AM signal produces a current of 4.8 A. The modulation is 90 percent. Calculate (a) the carrier power, (b) the total power, and (c) the sideband power.

a.  $P_c = I^2 R = (4.8)^2(40) = (23.04)(40) = 921.6 \text{ W}$

b.  $I_T = I_c \sqrt{1 + \frac{m^2}{2}} = 4.8 \sqrt{1 + \frac{(0.9)^2}{2}} = 4.8 \sqrt{1 + \frac{0.81}{2}}$

$$I_T = 4.8 \sqrt{1.405} = 5.7 \text{ A}$$

$$P_T = I_T^2 R = (5.7)^2(40) = 32.49(40) = 1295 \text{ W}$$

c.  $P_{\text{SB}} = P_T - P_c = 1295 - 921.6 = 373.4 \text{ W (186.7 W each sideband)}$

### Example 3-5

The transmitter in Example 3-4 experiences an antenna current change from 4.8 A unmodulated to 5.1 A. What is the percentage of modulation?

$$\begin{aligned} m &= \sqrt{2 \left[ \left( \frac{I_T}{I_c} \right)^2 - 1 \right]} \\ &= \sqrt{2 \left[ \left( \frac{5.1}{4.8} \right)^2 - 1 \right]} \\ &= \sqrt{2[(1.0625)^2 - 1]} \\ &= \sqrt{2(1.13 - 1)} \\ &= \sqrt{2(0.13)} \\ &= \sqrt{0.26} \end{aligned}$$

$$m = 0.51$$

The percentage of modulation is 51.



## Example 3-6

What is the power in one sideband of the transmitter in Example 3-4?

$$P_{SB} = m^2 \frac{P_c}{4} = \frac{(0.9)^2(921.6)}{4} = \frac{746.5}{4} = 186.6 \text{ W}$$

Despite its inefficiency, AM is still widely used because it is simple and effective. It is used in AM radio broadcasting, CB radio, TV broadcasting, and aircraft tower communication. Some simple control radios use ASK because of its simplicity. Examples are garage door openers and remote keyless entry devices on cars. AM is also widely used in combination with phase modulation to produce quadrature amplitude modulation (QAM) which facilitates high-speed data transmissions in modems, cable TV, and some wireless applications.

## 3-5 Single-Sideband Modulation

In amplitude modulation, two-thirds of the transmitted power is in the carrier, which itself conveys no information. The real information is contained within the sidebands. One way to improve the efficiency of amplitude modulation is to suppress the carrier and eliminate one sideband. The result is a single-sideband (SSB) signal. SSB is a form of AM that offers unique benefits in some types of electronic communication.

### DSB Signals

The first step in generating an SSB signal is to suppress the carrier, leaving the upper and lower sidebands. This type of signal is referred to as a *double-sideband suppressed carrier (DSSC or DSB)* signal. The benefit, of course, is that no power is wasted on the carrier. Double-sideband suppressed carrier modulation is simply a special case of AM with no carrier.

A typical DSB signal is shown in Fig. 3-15. This signal, the algebraic sum of the two sinusoidal sidebands, is the signal produced when a carrier is modulated by a single-tone sine wave information signal. The carrier is suppressed, and the time-domain DSB signal is a sine wave at the carrier frequency, varying in amplitude as shown. Note that the envelope of this waveform is not the same as that of the modulating signal, as

Single-sideband modulation

Double-sideband suppressed carrier (DSSC or DSB)

**Figure 3-15** A time-domain display of a DSB AM signal.

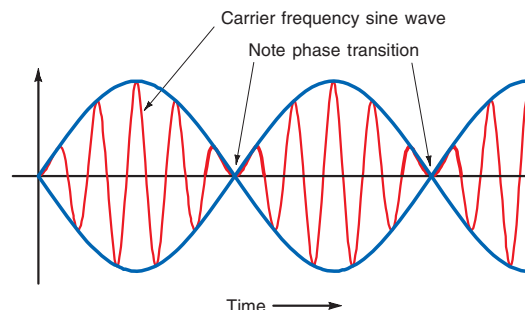

Time-domain display

**Figure 3-16** A frequency-domain display of DSB signal.

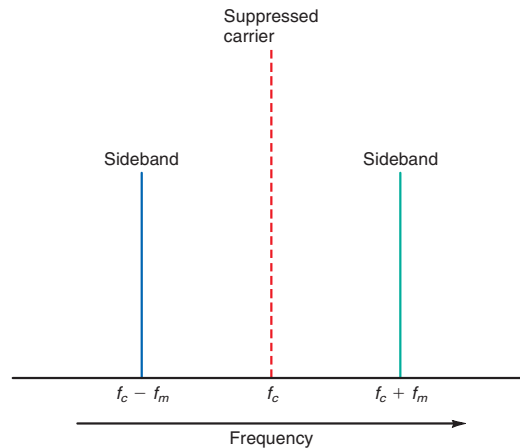

it is in a pure AM signal with carrier. A unique characteristic of the DSB signal is the phase transitions that occur at the lower-amplitude portions of the wave. In Fig. 3-15, note that there are two adjacent positive-going half-cycles at the null points in the wave. That is one way to tell from an oscilloscope display whether the signal shown is a true DSB signal.

#### Frequency-domain display

A *frequency-domain display* of a DSB signal is given in Fig. 3-16. As shown, the spectrum space occupied by a DSB signal is the same as that for a conventional AM signal.

Double-sideband suppressed carrier signals are generated by a circuit called a *balanced modulator*. The purpose of the balanced modulator is to produce the sum and difference frequencies but to cancel or balance out the carrier. Balanced modulators are covered in detail in Chap. 4.

Despite the fact that elimination of the carrier in DSB AM saves considerable power, DSB is not widely used because the signal is difficult to demodulate (recover) at the receiver. One important application for DSB, however, is the transmission of the color information in a TV signal.

## SSB Signals

In DSB transmission, since the sidebands are the sum and difference of the carrier and modulating signals, the information is contained in both sidebands. As it turns out, there is no reason to transmit both sidebands in order to convey the information. One sideband can be suppressed; the remaining sideband is called a *single-sideband suppressed carrier* (SSSC or SSB) signal. SSB signals offer four major benefits.

#### Single-sideband suppressed carrier (SSSC or SSB)

### GOOD TO KNOW

Although eliminating the carrier in DSB AM saves a great deal of power, DSB is not widely used because the signal is difficult to demodulate at the receiver. DSB is, however, used to transmit the color information in a TV signal.

1. The primary benefit of an SSB signal is that the spectrum space it occupies is only one-half that of AM and DSB signals. This greatly conserves spectrum space and allows more signals to be transmitted in the same frequency range.
2. All the power previously devoted to the carrier and the other sideband can be channeled into the single sideband, producing a stronger signal that should carry farther and be more reliably received at greater distances. Alternatively, SSB transmitters can be made smaller and lighter than an equivalent AM or DSB transmitter because less circuitry and power are used.
3. Because SSB signals occupy a narrower bandwidth, the amount of noise in the signal is reduced.
4. There is less selective fading of an SSB signal over long distances. An AM signal is really multiple signals, at least a carrier and two sidebands. These are on different

**Figure 3-17** An SSB signal produced by a 2-kHz sine wave modulating a 14.3-MHz sine wave carrier.

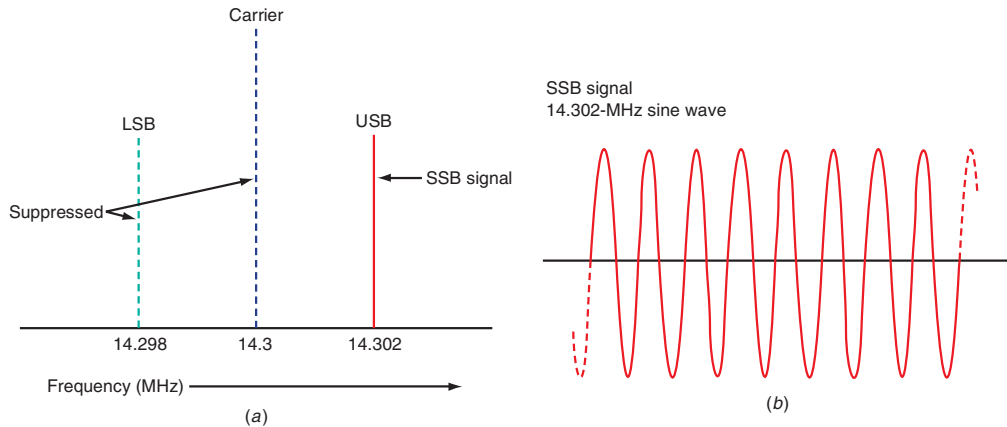

frequencies, so they are affected in slightly different ways by the ionosphere and upper atmosphere, which have a great influence on radio signals of less than about 50 MHz. The carrier and sidebands may arrive at the receiver at slightly different times, causing a phase shift that can, in turn, cause them to add in such a way as to cancel one another rather than add up to the original AM signal. Such cancellation, or *selective fading*, is not a problem with SSB since only one sideband is being transmitted.

**Selective fading**

An SSB signal has some unusual characteristics. First, when no information or modulating signal is present, no RF signal is transmitted. In a standard AM transmitter, the carrier is still transmitted even though it may not be modulated. This is the condition that might occur during a voice pause on an AM broadcast. But since there is no carrier transmitted in an SSB system, no signals are present if the information signal is zero. Sidebands are generated only during the modulation process, e.g., when someone speaks into a microphone. This explains why SSB is so much more efficient than AM.

Figure 3-17 shows the frequency- and time-domain displays of an SSB signal produced when a steady 2-kHz sine wave tone modulates a 14.3-MHz carrier. Amplitude modulation would produce sidebands of 14.298 and 14.302 MHz. In SSB, only one sideband is used. Figure 3-17(a) shows that only the upper sideband is generated. The RF signal is simply a constant-power 14.302-MHz sine wave. A time-domain display of this SSB signal is shown in Fig. 3-17(b).

Of course, most information signals transmitted by SSB are not pure sine waves. A more common modulation signal is voice, with its varying frequency and amplitude content. The voice signal creates a complex RF SSB signal that varies in frequency and amplitude over the narrow spectrum defined by the voice signal bandwidth. The waveform at the output of the SSB modulator has the same shape as the baseband waveform, but it is shifted in frequency.

## Disadvantages of DSB and SSB

The main disadvantage of DSB and SSB signals is that they are harder to recover, or demodulate, at the receiver. Demodulation depends upon the carrier being present. If the carrier is not present, then it must be regenerated at the receiver and reinserted into the signal. To faithfully recover the intelligence signal, the reinserted carrier must have the same phase and frequency as those of the original carrier. This is a difficult requirement. When SSB is used for voice transmission, the reinserted carrier can be made variable in frequency so that it can be adjusted manually while listening to recover an intelligible signal. This is not possible with some kinds of data signals.

Pilot carrier

To solve this problem, a low-level carrier signal is sometimes transmitted along with the two sidebands in DSB or a single sideband in SSB. Because the carrier has a low power level, the essential benefits of SSB are retained, but a weak carrier is received so that it can be amplified and reinserted to recover the original information. Such a low-level carrier is referred to as a *pilot carrier*. This technique is used in FM stereo transmissions as well as in the transmission of the color information in a TV picture.

## Signal Power Considerations

In conventional AM, the transmitted power is distributed among the carrier and two sidebands. For example, given a carrier power of 400 W with 100 percent modulation, each sideband will contain 100 W of power and the total power transmitted will be 600 W. The effective transmission power is the combined power in the sidebands, or 200 W.

An SSB transmitter sends no carrier, so the carrier power is zero. A given SSB transmitter will have the same communication effectiveness as a conventional AM unit running much more power. For example, a 10-W SSB transmitter offers the performance capabilities of an AM transmitter running a total of 40 W, since they both show 10 W of power in one sideband. The power advantage of SSB over AM is 4:1.

Peak envelope power (PEP)

In SSB, the transmitter output is expressed in terms of *peak envelope power (PEP)*, the maximum power produced on voice amplitude peaks. PEP is computed by the equation  $P = V^2/R$ . For example, assume that a voice signal produces a 360-V, peak-to-peak signal across a 50-Ω load. The rms voltage is 0.707 times the peak value, and the peak value is one-half the peak-to-peak voltage. In this example, the rms voltage is  $0.707(360/2) = 127.26$  V.

The peak envelope power is then

$$PEP = V_{rms}^2/R = \frac{(127.26)^2}{50} = 324 \text{ W}$$

The PEP input power is simply the dc input power of the transmitter's final amplifier stage at the instant of the voice envelope peak. It is the final amplifier stage dc supply voltage multiplied by the maximum amplifier current that occurs at the peak, or

$$PEP = V_s I_{max}$$

where  $V_s$  = amplifier supply voltage

$I_{max}$  = current peak

For example, a 450-V supply with a peak current of 0.8 A produces a PEP of  $450(0.8) = 360$  W.

Note that voice amplitude peaks are produced only when very loud sounds are generated during certain speech patterns or when some word or sound is emphasized. During normal speech levels, the input and output power levels are much less than the PEP level. The average power is typically only one-fourth to one-third of the PEP value with typical human speech:

$$P_{avg} = \frac{PEP}{3} \quad \text{or} \quad P_{avg} = \frac{PEP}{4}$$

With a PEP of 240 W, the average power is only 60 to 80 W. Typical SSB transmitters are designed to handle only the average power level on a continuous basis, not the PEP.

The transmitted sideband will, of course, change in frequency and amplitude as a complex voice signal is applied. This sideband will occupy the same bandwidth as one sideband in a fully modulated AM signal with carrier.

Incidentally, it does not matter whether the upper or lower sideband is used, since the information is contained in either. A filter is typically used to remove the unwanted sideband.

### GOOD TO KNOW

Because DSB and SSB signals are difficult to demodulate, a low-level carrier signal is sometimes transmitted along with the sideband(s). Because the carrier has a low power level, the benefits of SSB and DSB are retained. The carrier is then amplified and reinserted to recover the information.

### Example 3-7

An SSB transmitter produces a peak-to-peak voltage of 178 V across a 75- $\Omega$  antenna load. What is the PEP?

$$V_p = \frac{V_{p-p}}{2} = \frac{178}{2} = 89 \text{ V}$$

$$V_{\text{rms}} = 0.707 V_p = 0.707(89) = 62.9 \text{ V}$$

$$P = \frac{V^2}{R} = \frac{(62.9)^2}{75} = 52.8 \text{ W}$$

$$\text{PEP} = 52.8 \text{ W}$$

### Example 3-8

An SSB transmitter has a 24-V dc power supply. On voice peaks the current achieves a maximum of 9.3 A.

- a. What is the PEP?

$$\text{PEP} = V_s I_m = 24(9.3) = 223.2 \text{ W}$$

- b. What is the average power of the transmitter?

$$P_{\text{avg}} = \frac{\text{PEP}}{3} = \frac{223.2}{3} = 74.4 \text{ W}$$

$$P_{\text{avg}} = \frac{\text{PEP}}{4} = \frac{223.2}{4} = 55.8 \text{ W}$$

$$P_{\text{avg}} = 55.8 \text{ to } 74.4 \text{ W}$$

## Applications of DSB and SSB

Both DSB and SSB techniques are widely used in communication. SSB signals are still used in some two-way radios. Two-way SSB communication is used in marine applications, in the military, and by hobbyists known as radio amateurs (hams). DSB signals are used in FM and TV broadcasting to transmit two-channel stereo signals and to transmit the color information for a TV picture.

An unusual form of AM is that used in TV broadcasting. A TV signal consists of the picture (video) signal and the audio signal, which have different carrier frequencies. The audio carrier is frequency-modulated, but the video information amplitude-modulates the picture carrier. The picture carrier is transmitted, but one sideband is partially suppressed.

Video information typically contains frequencies as high as 4.2 MHz. A fully amplitude-modulated TV signal would then occupy  $2(4.2) = 8.4$  MHz. This is an excessive amount of bandwidth that is wasteful of spectrum space because not all of it is required to reliably transmit a TV signal. To reduce the bandwidth to the 6-MHz

### GOOD TO KNOW

For SSB transmissions, it does not matter whether the upper or lower sideband is used, since the information is contained in both.

**Figure 3-18** Vestigial sideband transmission of a TV picture signal.

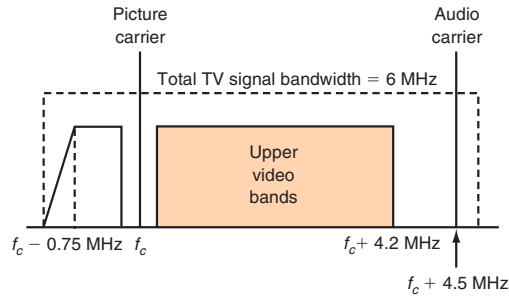

Vestigial sideband (VSB) signal

maximum allowed by the FCC for TV signals, a portion of the lower sideband of the TV signal is suppressed, leaving only a small part, or vestige, of the lower sideband. This arrangement, known as a *vestigial sideband (VSB) signal*, is illustrated in Fig. 3-18. Video signals above 0.75 MHz (750 kHz) are suppressed in the lower (vestigial) sideband, and all video frequencies are transmitted in the upper sideband.

The newer high-definition or digital TV also uses VSB but with multilevel digital modulation called VSB.

## 3-6 Classification of Radio Emissions

Figure 3-19 shows the codes used to designate the many types of signals that can be transmitted by radio and wire. The basic code is made up of a capital letter and a number, and lowercase subscript letters are used for more specific definitions. For example, a basic AM voice signal such as that heard on the AM broadcast band or on a CB or aircraft radio has the code A3. All the variations of AM using voice or video intelligence have the A3 designation, but subscript letters are used to distinguish them. Examples of codes designating signals described in this chapter are as follows:

- DSB two sidebands, full carrier = A3
- DSB two sidebands, suppressed carrier = A3<sub>b</sub>
- SSB single sideband, suppressed carrier = A3<sub>j</sub>
- SSB single sideband, 10 percent pilot carrier = A3<sub>a</sub>
- Vestigial sideband TV = A3<sub>c</sub>
- OOK and ASK = A1

Note that there are special designations for fax and pulse transmissions, and that the number 9 covers any special modulation or techniques not covered elsewhere. When a number precedes the letter code, the number refers to bandwidth in kilohertz. For example, the designation 10A3 refers to a 10-kHz bandwidth voice AM signal. The designation 20A3<sub>b</sub> refers to an AM SSB signal with full carrier and message frequency to 20 kHz.

Another system used to describe a signal is given in Fig. 3-20. It is similar to the method just described, but with some variations. This is the definition used by the standards organization International Telecommunications Union (ITU). Some examples are

- A3F amplitude-modulated analog TV
- J3E SSB voice
- F2D FSK data
- G7E phase-modulated voice, multiple signals

**Figure 3-19** Radio emission code designations.

Letter	A	Amplitude modulation
	F	Frequency modulation
Number	P	Phase modulation
	0	Carrier ON only, no message (radio beacon)
	1	Carrier ON/OFF, no message (Morse code, radar)
	2	Carrier ON, keyed tone ON/OFF (code)
	3	Telephony, message as voice or music
	4	Fax, nonmoving graphics (slow-scan TV)
	5	Vestigial sideband (commercial TV)
	6	Four-frequency duplex telegraphy
	7	Multiple sidebands each with different message
	8	
Subscripts	9	General (all others)
	None	Double sideband, full carrier
	a	Single sideband, reduced carrier
	b	Double sideband, no carrier
	c	Vestigial sideband
	d	Carrier pulses only, pulse amplitude modulation (PAM)
	e	Carrier pulses only, pulse width modulation (PWM)
	f	Carrier pulses only, pulse position modulation (PPM)
	g	Quantized pulses, digital video
	h	Single sideband, full carrier
	j	Single sideband, no carrier

**Figure 3-20** ITU emissions designations.

Type of Modulation	
N	Unmodulated carrier
A	Amplitude modulation
J	Single sideband
F	Frequency modulation
G	Phase modulation
P	Series of pulses, no modulation
Type of Modulating Signals	
0	None
1	Digital, single channel, no modulation
2	Digital, single channel, with modulation
3	Analog, single channel
7	Digital, two or more channels
8	Analog, two or more channels
9	Analog plus digital
Type of Intelligence Signal	
N	None
A	Telegraphy, human
B	Telegraphy, machine
C	Fax
D	Data, telemetry, control signals
E	Telephony (human voice)
F	Video, TV
W	Some combination of any of the above

# CHAPTER REVIEW

## Summary

In amplitude modulation, an increase or a decrease in the amplitude of the modulating signal causes a corresponding increase or decrease in both the positive and the negative peaks of the carrier amplitude. Interconnecting the adjacent positive or negative peaks of the carrier waveform yields the shape of the modulating information signal, known as the envelope.

Using trigonometric functions, we can form mathematical expressions for the carrier and the modulating signal, and we combine these to create a formula for the complete modulated wave. Modulators (circuits that produce amplitude modulation) compute the product of the carrier and modulating signals.

The relationship between the amplitudes of the modulating signal and the carrier is expressed as the modulation index  $m$ , a number between 0 and 1. If the amplitude of the modulating voltage is higher than the carrier voltage  $m > 1$ , then distortion, or overmodulation, will result.

When a carrier is modulated by an information signal, new signals at different frequencies are generated. These side frequencies, or sidebands, occur in the frequency spectrum directly above and below the carrier frequency. An AM signal is a composite of several signal voltages, the carrier, and the two sidebands, each of which produces power in the antenna.

Total transmitted power is the sum of the carrier power and the power in the two sidebands.

AM signals can be expressed through time-domain displays or frequency-domain displays.

In AM transmission, two-thirds of the transmitted power appears in the carrier, which itself conveys no information. One way to overcome this wasteful effect is to suppress the carrier. When the carrier is initially suppressed, both the upper and the lower sidebands are left, leaving a double-sideband suppressed (DSSC or DSB) signal. Because both sidebands are not necessary to transmit the desired information, one of the remaining sidebands can be suppressed, leaving a single-sideband (SSB) signal. SSB signals offer important benefits: they conserve spectrum space, produce strong signals, reduce noise, and result in less fading over long distances.

In SSB, the transmitter output is expressed as peak envelope power (PEP), the maximum power produced on voice amplitude peaks.

Both DSB and SSB techniques are widely used in communication. Two-way SSB communication is used in marine applications, in the military, and by hams. In some TV applications, to reduce the signal bandwidth to the 6-MHz maximum allowed by the FCC for TV signals, a vestigial sideband signal is used to suppress the lower sideband of the TV signal.

## Questions

1. Define modulation.
2. Explain why modulation is necessary or desirable.
3. Name the circuit that causes one signal to modulate another, and give the names of the two signals applied to this circuit.
4. In AM, how does the carrier vary in accordance with the information signal?
5. True or false? The carrier frequency is usually lower than the modulating frequency.
6. What is the outline of the peaks of the carrier signal called, and what shape does it have?
7. What are voltages that vary over time called?
8. Write the trigonometric expression for a sine wave carrier signal.
9. True or false? The carrier frequency remains constant during AM.
10. What mathematical operation does an amplitude modulator perform?
11. What is the ideal relationship between the modulating signal voltage  $V_m$  and the carrier voltage  $V_c$ ?
12. What is the modulation index called when it is expressed as a percentage?
13. Explain the effects of a modulation percentage greater than 100.
14. What is the name given to the new signals generated by the modulation process?
15. What is the name of the type of signal that is displayed on an oscilloscope?
16. What is the type of signal whose amplitude components are displayed with respect to frequency called, and on what instrument is this signal displayed?
17. Explain why complex nonsinusoidal and distorted signals produce a greater bandwidth AM signal than a simple sine wave signal of the same frequency.
18. What three signals can be added to give an AM wave?
19. What is the name given to an AM signal whose carrier is modulated by binary pulses?
20. What is the value of phasor representation of AM signals?
21. True or false? The modulating signal appears in the output spectrum of an AM signal.
22. What percentage of the total power in an AM signal is in the carrier? One sideband? Both sidebands?
23. Does the carrier of an AM signal contain any information? Explain.



24. What is the name of a signal that has both sidebands but no carrier?
25. What is the name of the circuit used to eliminate the carrier in DSB/SSB transmissions?
26. What is the minimum bandwidth AM signal that can be transmitted and still convey all the necessary intelligence?
27. State the four main benefits of SSB over conventional AM.
28. Name two applications for SSB and two applications for DSB.
29. Name the type of AM used in TV picture transmission. Why is it used? Draw the frequency-domain spectrum of the TV signal.
30. Using Figs. 3-19 and 3-20, write the designations for a pulse-amplitude-modulated radio signal and an amplitude-modulated ( $V_{SB}$ ) analog fax signal.
31. Explain the bandwidth requirements of a voice signal of 2 kHz and a binary data signal with a rate of 2 kHz.

## Problems

1. Give the formula for modulation index and explain its terms. □
2. An AM wave displayed on an oscilloscope has values of  $V_{\max} = 4.8$  and  $V_{\min} = 2.5$  as read from the graticule. What is the percentage of modulation?
3. What is the ideal percentage of modulation for maximum amplitude of information transmission? □
4. To achieve 75 percent modulation of a carrier of  $V_c = 50$  V, what amplitude of the modulating signal  $V_m$  is needed?
5. The maximum peak-to-peak value of an AM wave is 45 V. The peak-to-peak value of the modulating signal is 20 V. What is the percentage of modulation? □
6. What is the mathematical relationship of the carrier and modulating signal voltages when overmodulation occurs?
7. An AM radio transmitter operating on 3.9 MHz is modulated by frequencies up to 4 kHz. What are the maximum upper and lower side frequencies? What is the total bandwidth of the AM signal? □
8. What is the bandwidth of an AM signal whose carrier is 2.1 MHz modulated by a 1.5-kHz square wave with significant harmonics up to the fifth? Calculate all the upper and lower sidebands produced.
9. How much power appears in one sideband of an AM signal of a 5-kW transmitter modulated by 80 percent? □
10. What is the total power supplied by an AM transmitter with a carrier power of 2500 W and modulation of 77 percent?
11. An AM signal has a 12-W carrier and 1.5 W in each sideband. What is the percentage of modulation?
12. An AM transmitter puts a carrier of 6 A into an antenna whose resistance is  $52 \Omega$ . The transmitter is modulated by 60 percent. What is the total output power?
13. The antenna current produced by an unmodulated carrier is 2.4 A into an antenna with a resistance of  $75 \Omega$ . When amplitude-modulated, the antenna current rises to 2.7 A. What is the percentage of modulation?
14. A ham transmitter has a carrier power of 750 W. How much power is added to the signal when the transmitter is 100 percent modulated?
15. An SSB transmitter has a power supply voltage of 250 V. On voice peaks, the final amplifier draws a current of 3.3 A. What is the input PEP?
16. The peak-to-peak output voltage of 675 V appears across a  $52\text{-}\Omega$  antenna on voice peaks in an SSB transmitter. What is the output PEP?
17. What is the average output power of an SSB transmitter rated at 100-W PEP?
18. An SSB transmitter with a carrier of 2.3 MHz is modulated by an intelligence signal in the 150-Hz to 4.2-kHz range. Calculate the frequency range of the lower sideband.

□ Answers to Selected Problems follow Chap. 22.

## Critical Thinking

1. Can intelligence be sent without a carrier? If so, how?
2. How is the output power of an SSB transmitter expressed?
3. A subcarrier of 70 kHz is amplitude-modulated by tones of 2.1 and 6.8 kHz. The resulting AM signal is then used to amplitude-modulate a carrier of 12.5 MHz. Calculate all sideband frequencies in the composite signal, and draw a frequency-domain display of the signal. Assume 100 percent modulation. What is the bandwidth occupied by the complete signal?
4. Explain how you could transmit two independent baseband information signals by using SSB on a common carrier frequency.
5. An AM signal with 100 percent modulation has an upper sideband power of 32 W. What is the carrier power?
6. Can an information signal have a higher frequency than that of the carrier signal? What would happen if a 1-kHz signal amplitude-modulated a 1-kHz carrier signal?